

Data Sheet



Article number: 20804016B

Description: E+G Thrust pad
GN 6311.1-16-K

Measures

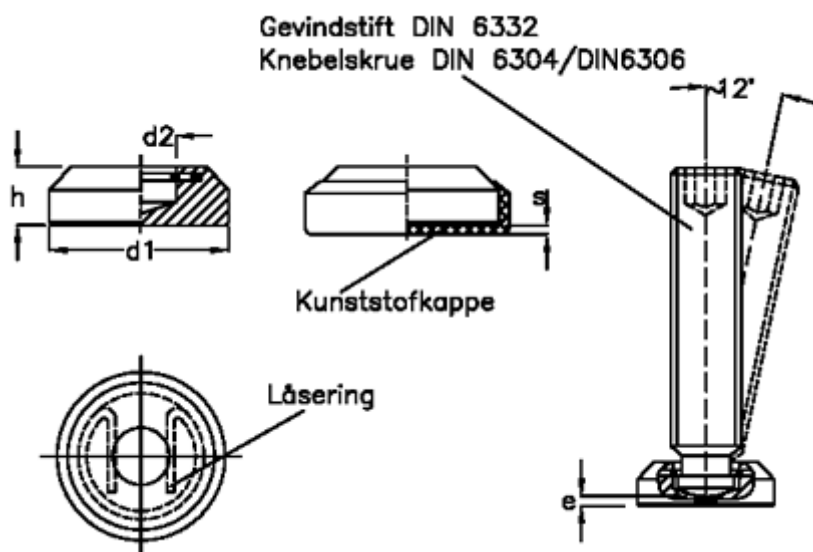

d1	= 16
d2	= 6.3
e	= 2.2
H	= 8
s	= 1.5
Thread	= M8